



12ª Conferência sobre Tecnologia de Equipamentos

18 a 21 de junho de 2013

Enotel Resort & SPA
Porto de Galinhas - PE

New Applications of the NDT Simulation Platform CIVA 11



Contents

- Introduction
- CIVA UT
 - ✓ Capabilities
 - ✓ New features in CIVA 11
 - ✓ Applications
- CIVA ET
 - ✓ Capabilities
 - ✓ New features in CIVA 11
 - ✓ Applications
- CIVA RT
 - ✓ Capabilities
 - ✓ New features in CIVA 11
 - ✓ Applications

Contents

- **Introduction**
- CIVA UT:
 - ✓ Capabilities
 - ✓ New features in CIVA 11
 - ✓ Applications
- CIVA ET
 - ✓ Capabilities
 - ✓ New features in CIVA 11
 - ✓ Applications
- CIVA RT
 - ✓ Capabilities
 - ✓ New features in CIVA 11
 - ✓ Applications

- Software dedicated to NDE simulation
- Multi-techniques:
 - ✓ UT : Ultrasounds
 - ✓ GWT: Guided Waves
 - ✓ ET : Eddy Current
 - ✓ RT : Radiography
 - ✓ CT: Computed Tomography
 - ✓ Analysis tools
- Developed by CEA
(French Atomic Energy commission: Research center)
 - ✓ R&D NDT department: >100 people
 - ✓ Development & validation of CIVA: 30 people
- Based mostly on semi-analytical models (fast calculation times)
- Distributed by EXTENDE since 2010
- A users community with more than 200 companies in 37 countries

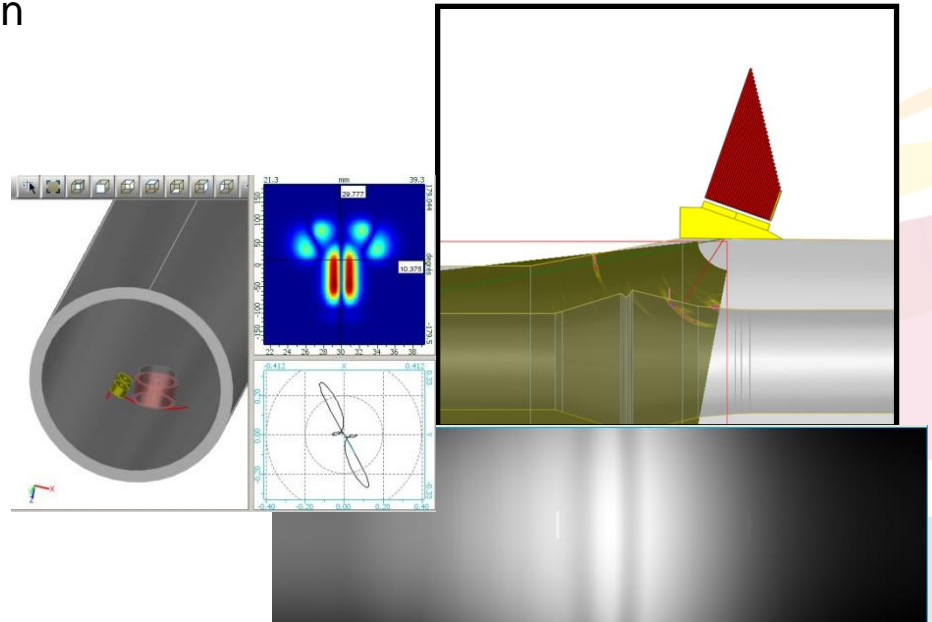

- CIVA Distribution
- Technical support
- Training courses

- Consulting



CIVA
NDE I11



- Involved in collaborative R&D projects

Benefits of modeling in NDT

- Help for methods and probes design:
 - ✓ Time and cost savings: less prototypes
 - ✓ Improve performances and firm up choices
 - ✓ Help with introducing new innovations
 - ✓ Check controllability : Help in designing components
- Expertise:
 - ✓ Comparison between acquisitions and simulation
 - ✓ Better understanding of physical phenomena
 - ✓ Support for the detection / characterization
- Support qualification documentation (parametric studies)
- Technical and visual tool to share knowledge:
 - ✓ Illustrate to convince (bid proposal)
 - ✓ Explain to colleagues, suppliers, customers, etc.
 - ✓ Train operators or students

Contents

- Introduction
- CIVA UT:
 - ✓ Capabilities
 - ✓ New features in CIVA 11
 - ✓ Applications
- CIVA ET
 - ✓ Capabilities
 - ✓ New features in CIVA 11
 - ✓ Applications
- CIVA RT
 - ✓ Capabilities
 - ✓ New features in CIVA 11
 - ✓ Applications

- CIVA UT includes:
 - ✓ Beam Calculation tool
 - ✓ Inspection Simulation tool
 - ✓ Phased-array settings calculations (delay laws, etc.)
 - ✓ POD simulation

- Techniques covered:
 - ✓ Pulse-echo conventional UT
 - ✓ Phased-Array
 - ✓ Tandem
 - ✓ TOFD

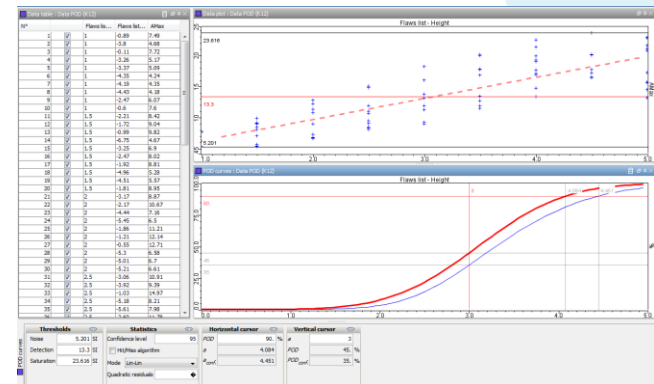
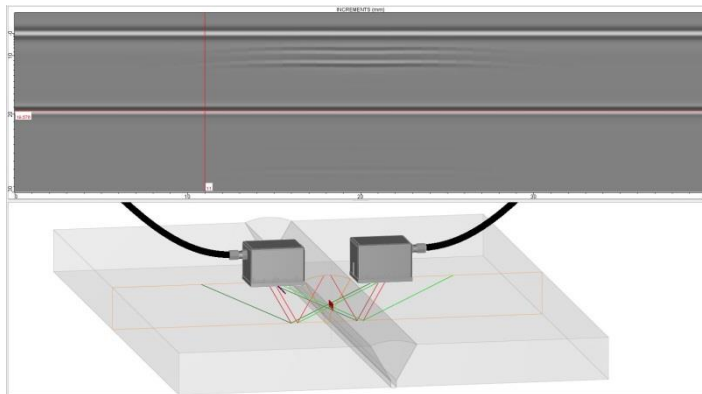
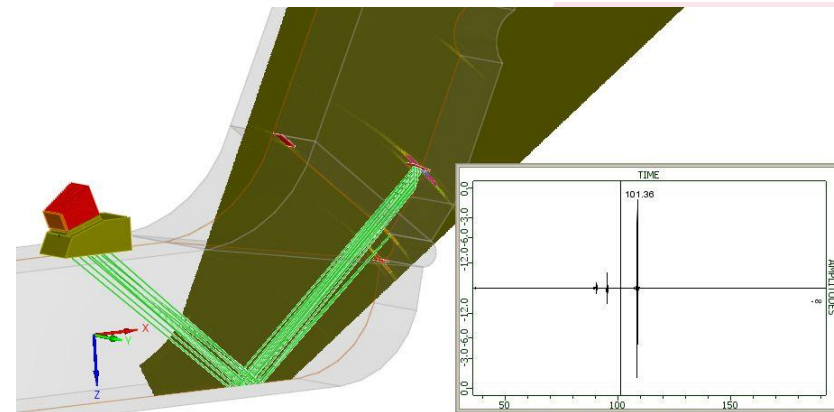
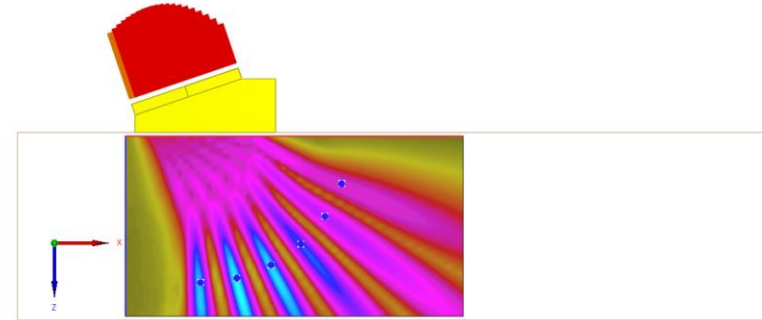

Main new features in CIVA11

- 3D CAD heterogeneous specimens:
 - ✓ Complex geometries
 - ✓ Assembled structures
 - ✓ Simulation with several solids
 - ✓ Welds
 - ✓ Cladding
 - ✓ Change of acoustic properties due to heat-treatment, etc.

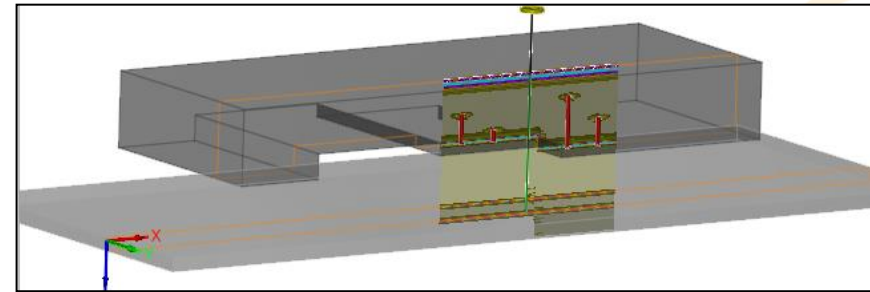

- Templates of various weld profiles defined according standards

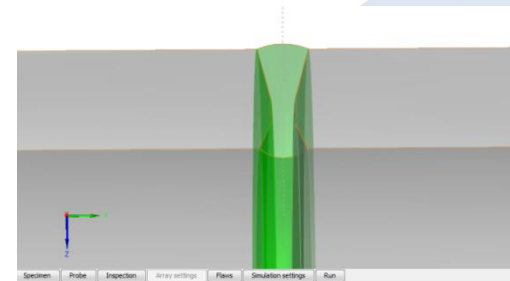

- Polycrystalline materials
 - ✓ Account for structural noise & attenuation vs grain size

Main new features in CIVA11

- Custom Phased-Array probes

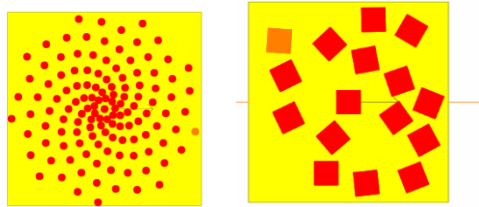

- Modes automatic identification

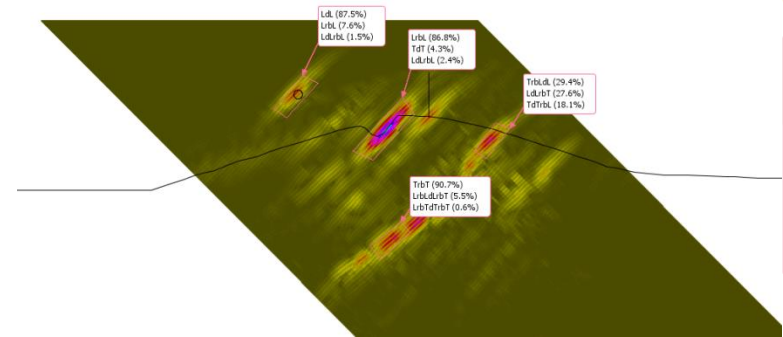

- Acquisition gates definition

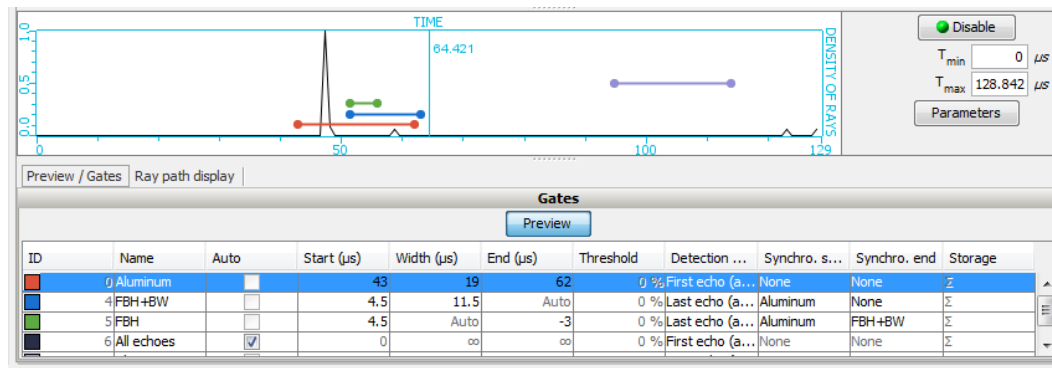

- Compatible with Omniscan[®] data files for analysis and signal processing in CIVA

Applications (1/2) Coteq

12ª Conferência sobre Tecnologia de Equipamentos

- Acquisition gates can be tested by simulation:
 - ✓ Defined versus time of flight
 - ✓ Defined versus other signals (synchronized gates)
- Applications: Step wedge block (carbon steel) with FBH
 - ✓ Inspected with a dual element 4MHz
 - ✓ Results without gate:

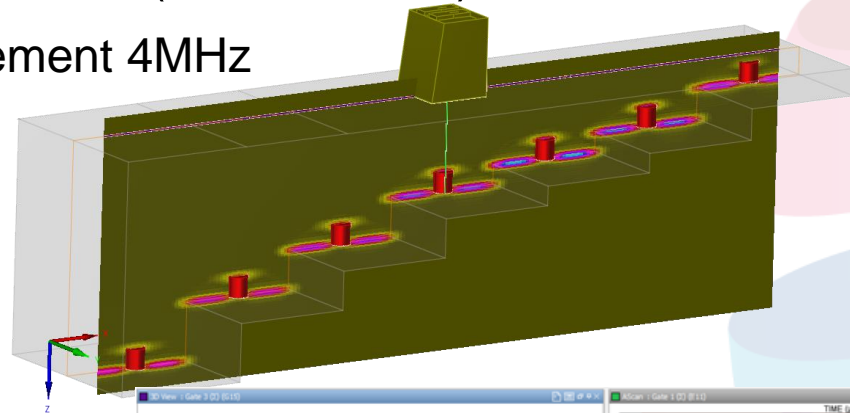

- ✓ Gates synchronized versus backwall echo (last peak):
- ✓ Capability to keep only FBH echoes and plot easily DGS curves

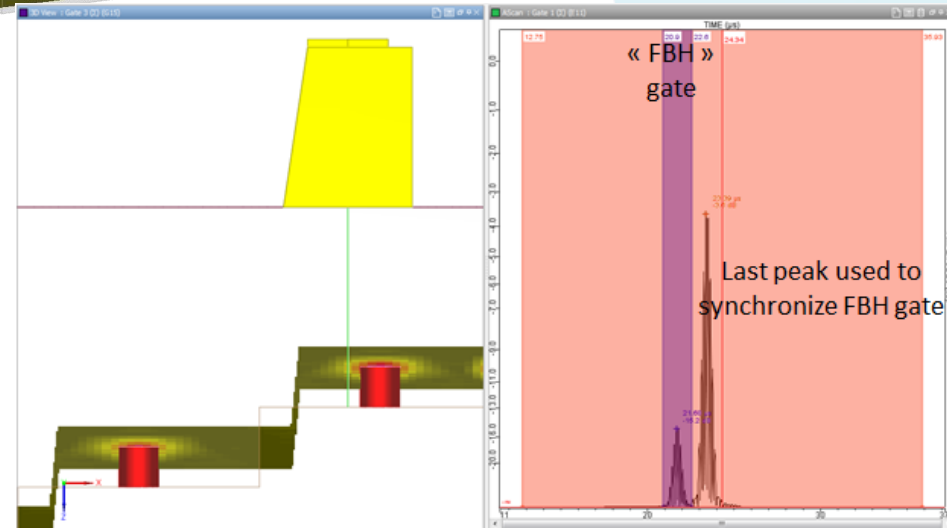

Applications (1/2) Coteq

12ª Conferência sobre Tecnologia de Equipamentos

- But at some positions, 2 backwall echoes can “overlap”:

- ✓ Depends on the beam size
- ✓ One backwall echo is trapped in the “FBH” gate: Unexpected signal
- ✓ Unstable gate
- ✓ Can happen in “real life”

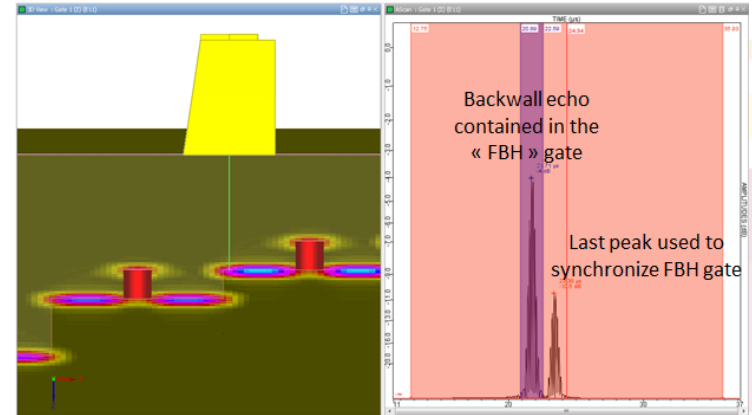

- Simulations can be used to identify such problems and optimize the gate or the block

- Results with a step wedge having smoother steps at some positions:

- Only FBH echoes kept,
- Plotting of DGS curve

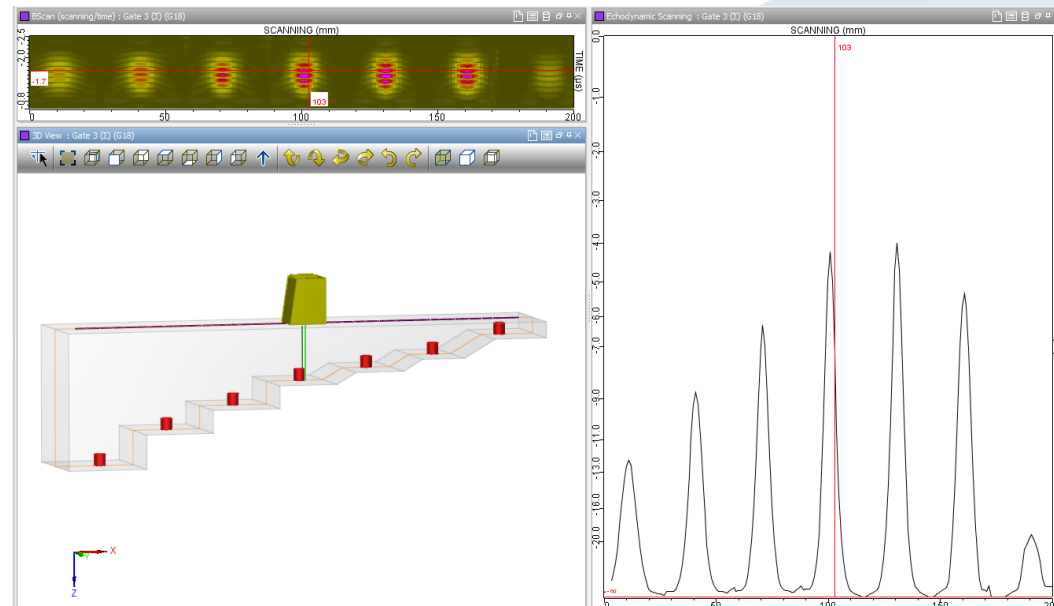

Applications (2/2) Coteq

12ª Conferência sobre Tecnologia de Equipamentos

- Simulate Weld Inspection by PA UT
- Examples: Modeling qualification tests of pipeline girthwelds inspection made with PipeWizard, Rotoscan, etc.
- Inspections rely on zonal discrimination approach
 - ✓ Weld divided into different area of 3mm height maximum
 - ✓ Each channel of the probe is dedicated to inspect one area
 - ✓ Relies on highly focused beam

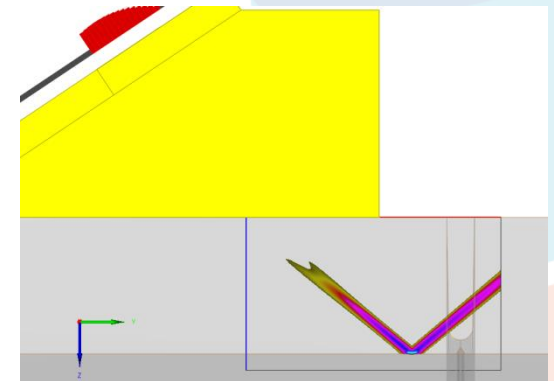
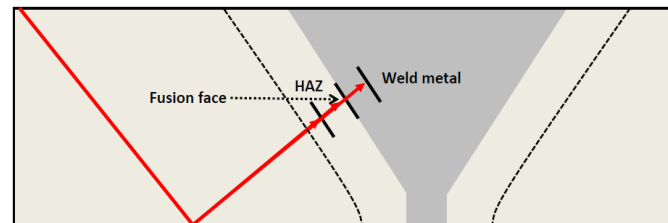
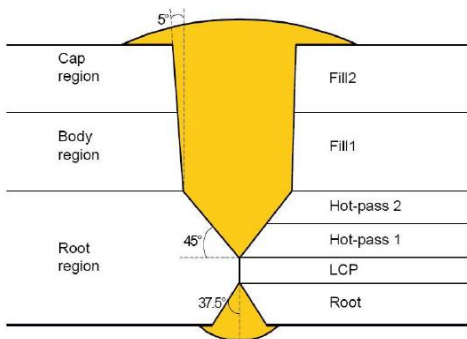

Applications (2/2) Coteq

12ª Conferência sobre Tecnologia de Equipamentos

- Simulation allows :
 - Simulate and optimize beam and delay laws
 - Predicting defect responses for the different channels

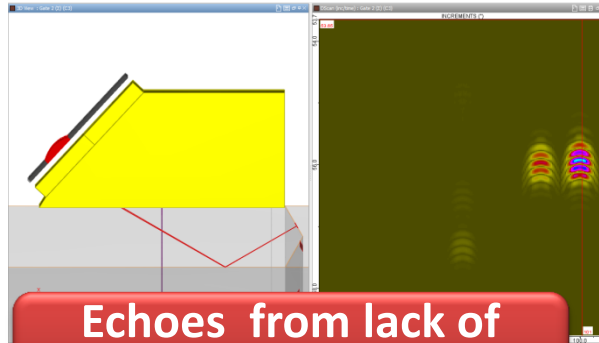

Echoes from lack of fusion (B-Scan view)

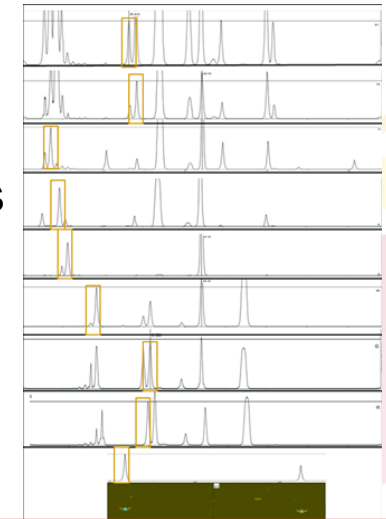

Charts of the different channels

- Interest of using simulation:
 - ✓ Can replace some part of the qualification tests (costly process)
 - ✓ Reach more reliable qualification: Easy to obtain additional data in order to cover more possible situations (defects, system position, probe parameters, etc.)
- ✓ Validation study of CIVA for Pipeline GirthWelds inspection published at ASNT2012

Contents

- Introduction
- CIVA UT:
 - ✓ Capabilities
 - ✓ New features in CIVA 11
 - ✓ Applications
- CIVA ET
 - ✓ Capabilities
 - ✓ New features in CIVA 11
 - ✓ Applications
- CIVA RT
 - ✓ Capabilities
 - ✓ New features in CIVA 11
 - ✓ Applications

- CIVA ET includes:
 - ✓ Field Calculation tool
 - ✓ Probe response (impedance diagram, lift-off signal)
 - ✓ Inspection Simulation tool
 - ✓ POD simulation
- Techniques covered:
 - ✓ Conventional ET
 - ✓ Eddy Current Array
 - ✓ Remote Field Technique

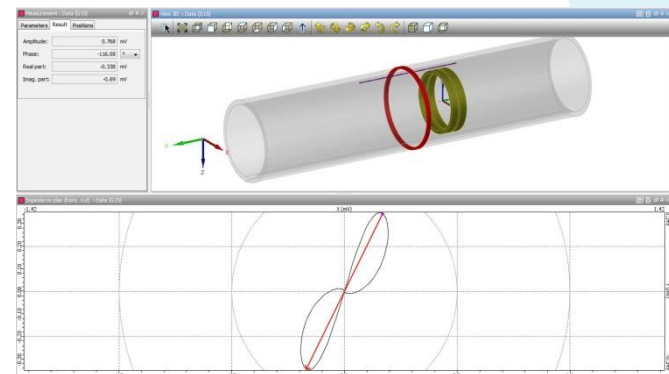
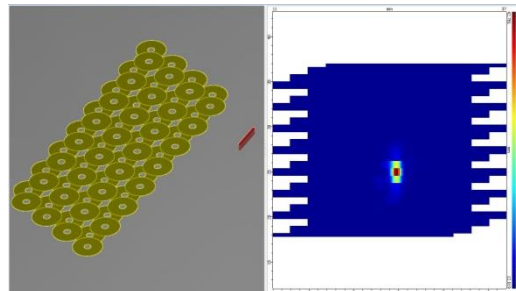
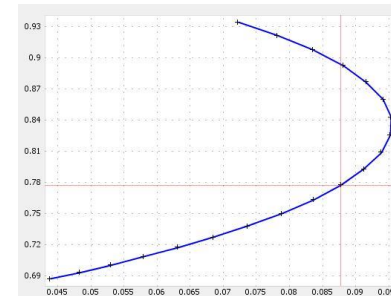
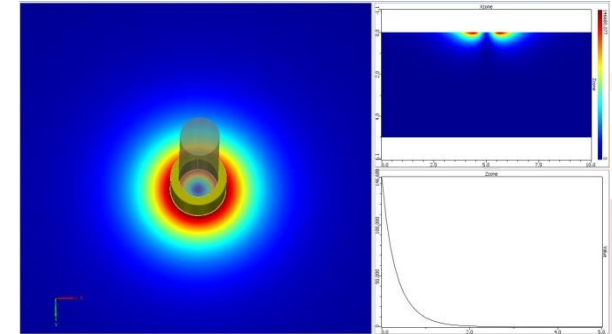

Main new features in CIVA11

- New “BEM” model adapted for thin flaw

→ more realistic simulation of complex cracks

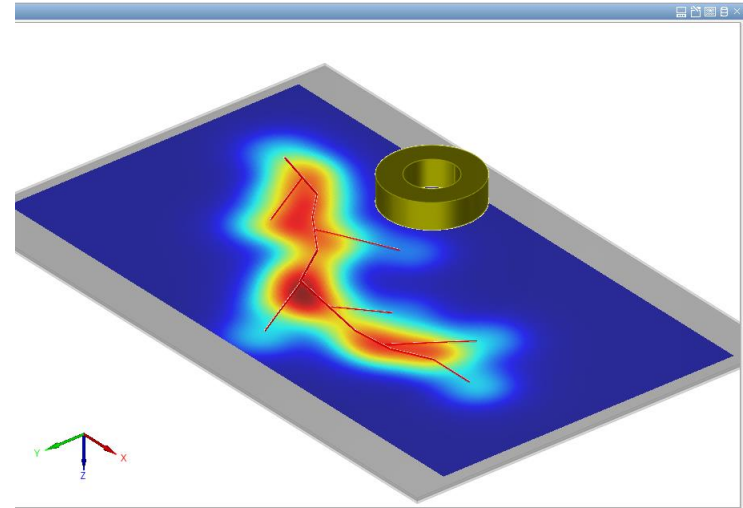

- Extension of coil libraries (D, meander, pancake, etc.)



Main new features in CIVA11

- EMAT probes (coupling with CIVA UT):
 - Electric field computation in CIVA ET
 - Defect response in CIVA UT
- Accounting for electrical parameters of ET system and probe by circuit coupling (stray capacitances, etc.)
- Heat exchanger tube expansion zone

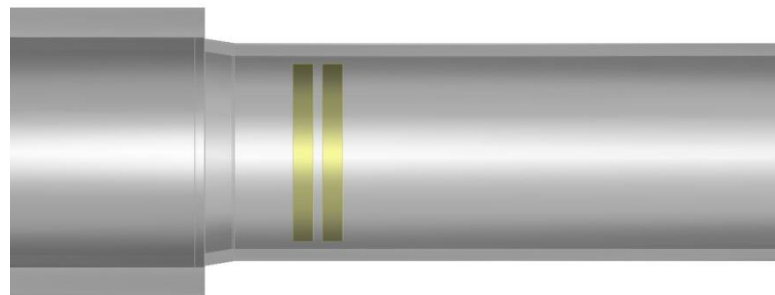
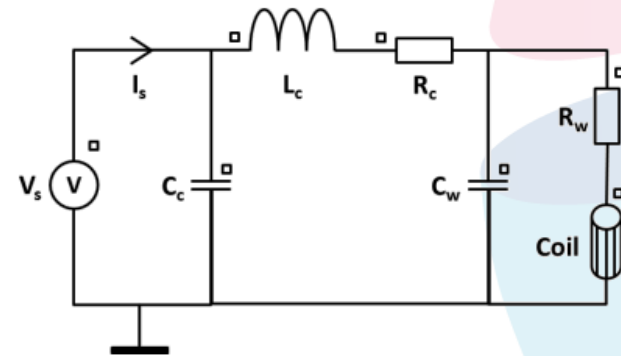
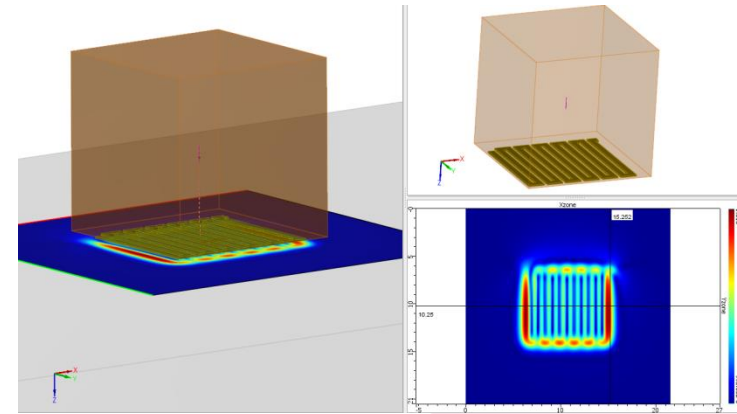

Applications

- Steam generator tube inspection by bobbin probe
 - ✓ Inconel tube of 9.84mm IR and 1.27mm thickness
 - ✓ Expanded radius ($\delta r=0.6\text{mm}$) to fit with a ferromagnetic tubesheet at its basis
 - ✓ Circumferential inner flaw of 1mm extension and 25% thickness
 - ✓ Inspection at 200 kHz
- Signal of the absolute channel:

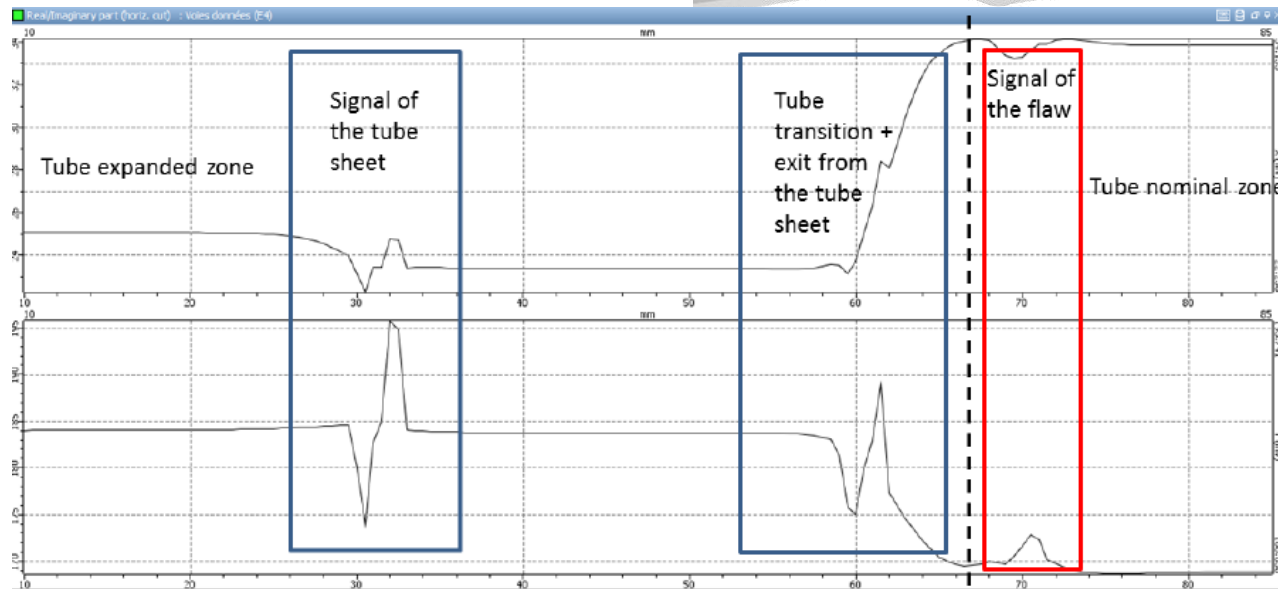
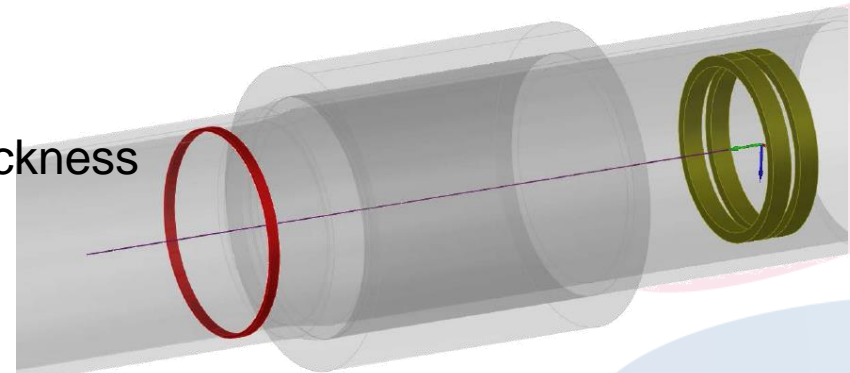

Applications

- Study of the influence of the transition zone on the flaw signal
 - ✓ Differential channel: Flaw in the nominal part

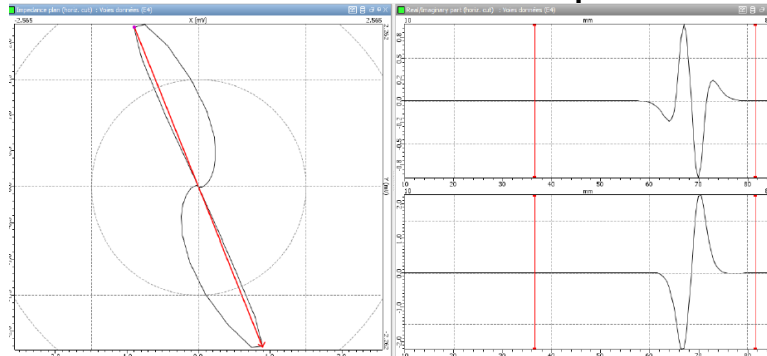

- ✓ Flaw located in the transition zone (red and blue curves) :
Decrease of the flaw signal amplitude

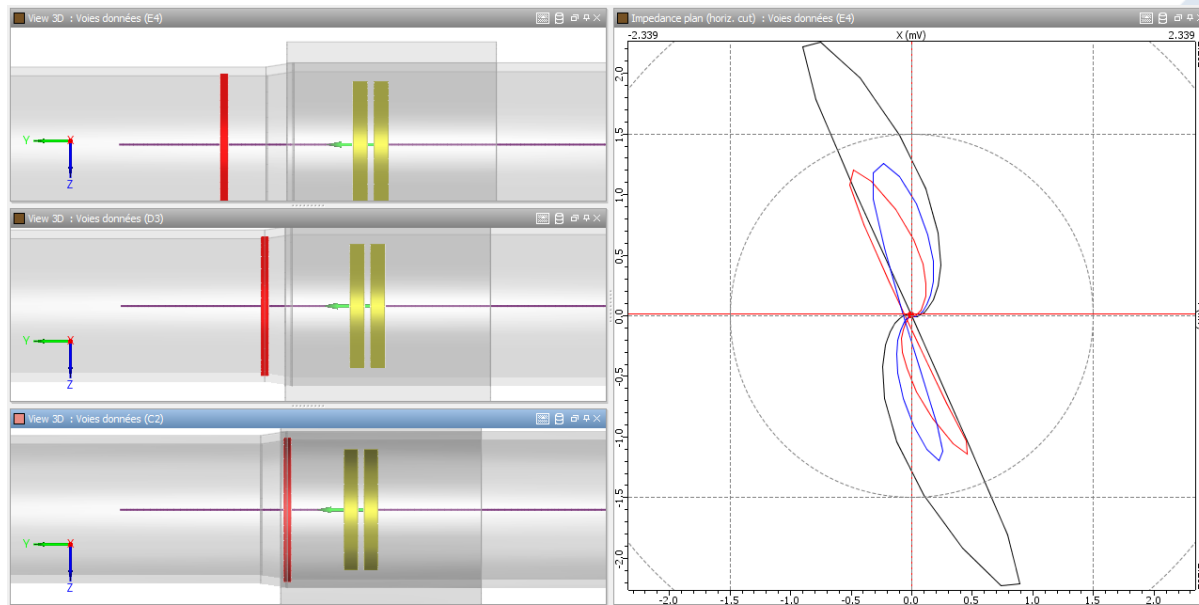

- CIVA RT-CT includes:

- ✓ Direct radiation (Beer-Lambert model)
- ✓ Scattered radiation (Monte-Carlo method)

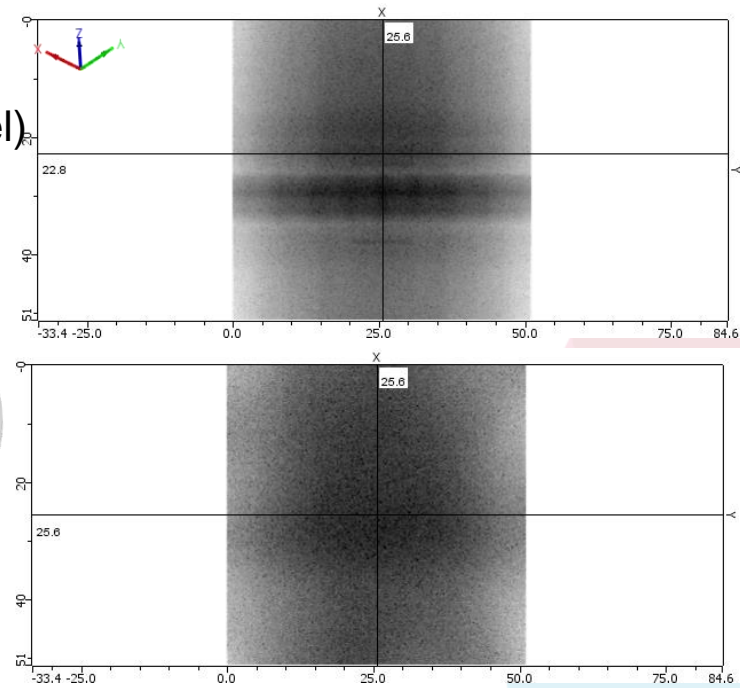
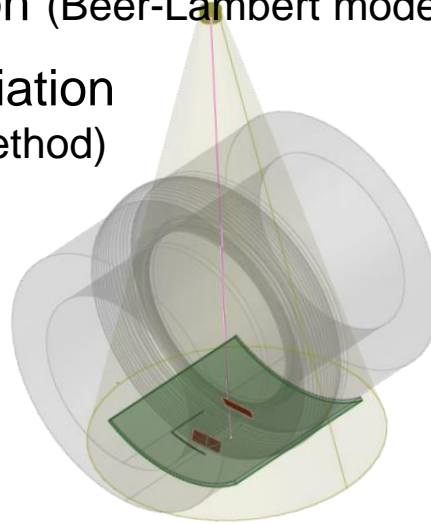

- Techniques covered:

- ✓ X-Ray
- ✓ Gamma-Ray
- ✓ Tomographic reconstruction (FDK, PixTV algo)

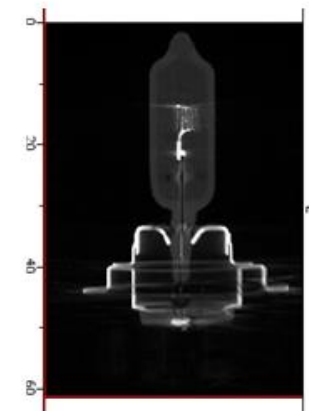

Main new features in CIVI11

- Heterogeneous 3D CAD geometries
- Digital radiography: Image plate detectors
- POD computation
- Scattering model accounts for pair creation (high energy phenomenon)
- Post-processing:
 - ✓ Detectability criteria
 - ✓ Fast Target dose/exposure computation by post-processing
- CT reconstruction algorithms available on experimental data

Applications

- New features: Simulate several objects in the same configuration
 - ✓ For instance: Work piece (turbine disk) + Wall (lead block)
 - ✓ Some backscattering phenomenon can be accounted for
- Inspected with Ir192 gamma ray source

- Build-up (1+scatt/direct) comparison with and without backscattering around the flaw

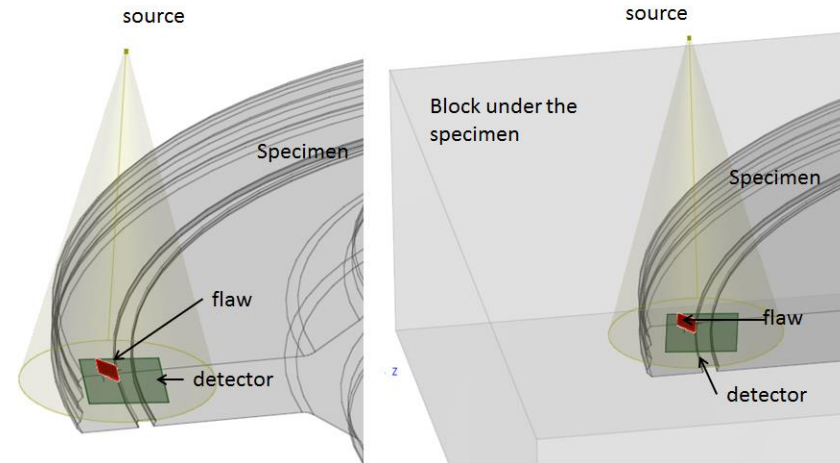

- With backscattering: Higher build-up = Noisy image
- Without backscattering

Build-up comparison and evaluation of the backscattering

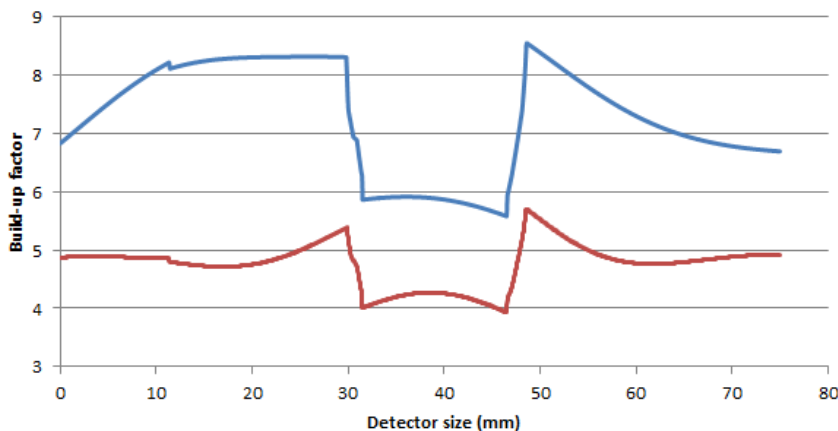

CONCLUSION

- Benefits: Improve cost-efficiency of NDT at different stages of the process
 - ✓ Design and qualification of inspection methods
 - ✓ Preparation of inspection
 - ✓ Expertise
 - ✓ Training
- CIVA 11: Numerous new capabilities in UT, ET, RT and CT
- CIVA 11 Guided Waves released soon
- A lot of potential applications
- Come to visit our booth #43
www.extende.com
contact@extende.com

